

Figure 1. SLR telescope reference point

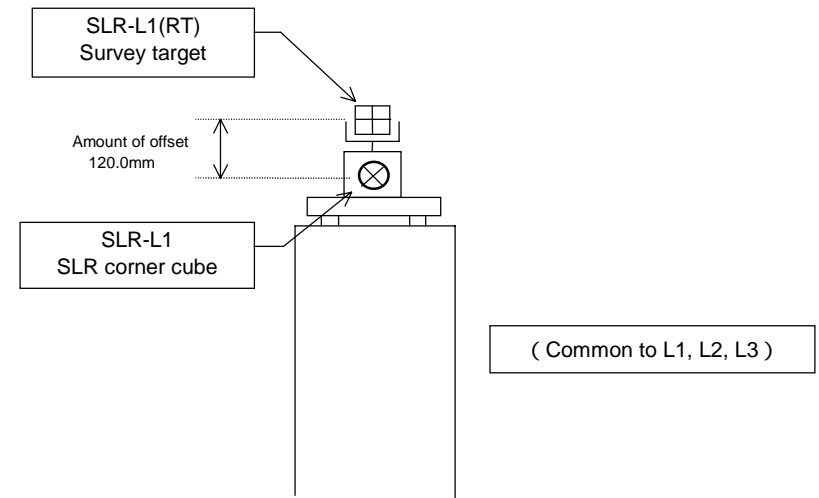

Figure 2. SLR external geodetic survey reference point (long pillar)

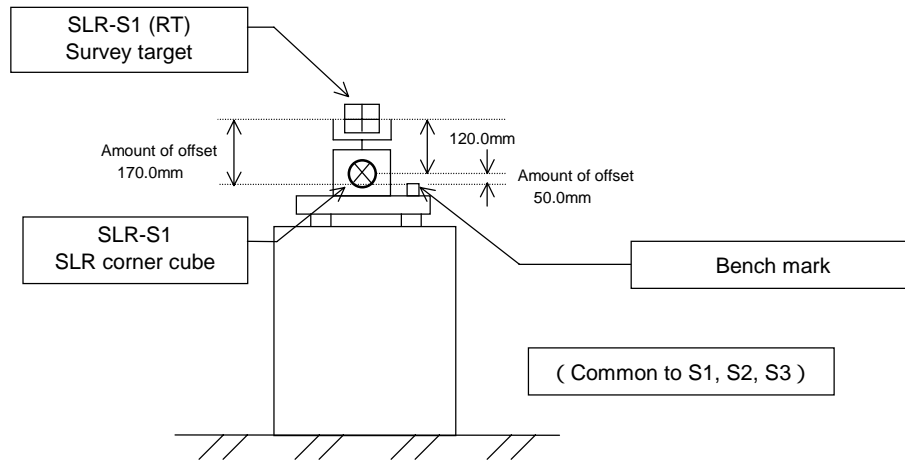

Figure 3. SLR external geodetic survey reference point (short pillar)

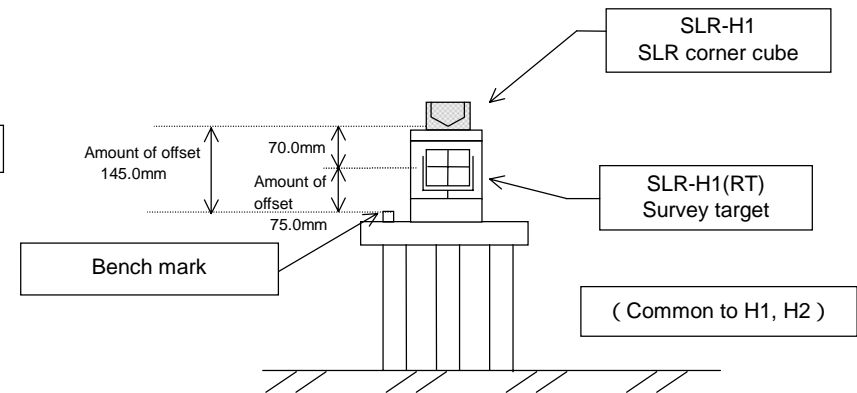

Figure 4. SLR leveling reference point

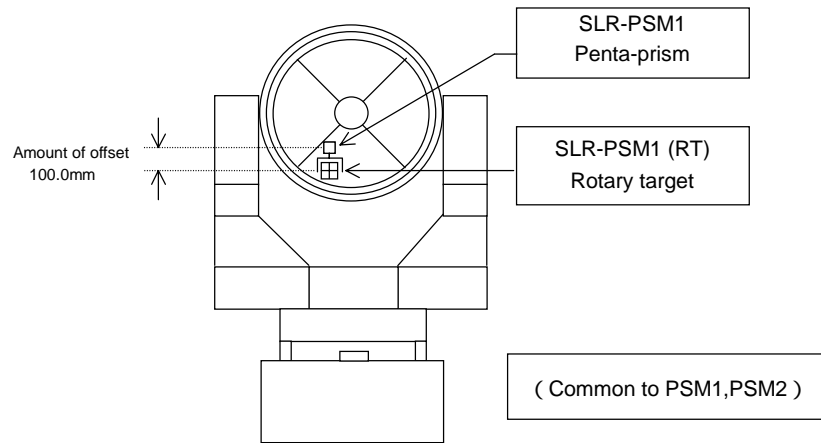

Figure 5. SLR prism

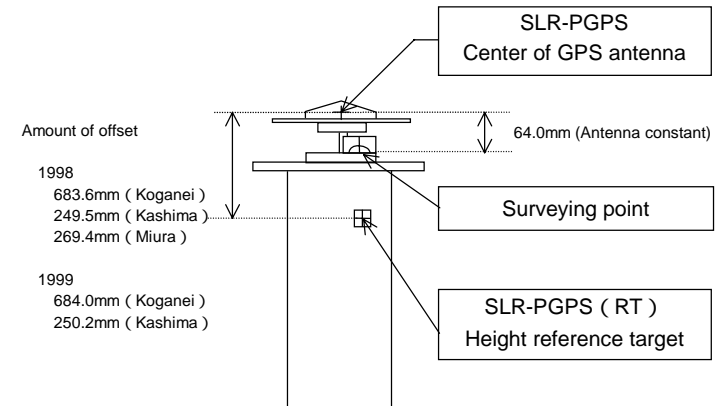

Figure 6. GPS antenna for SLR geodetic survey (Koganei, Kashima, Miura)

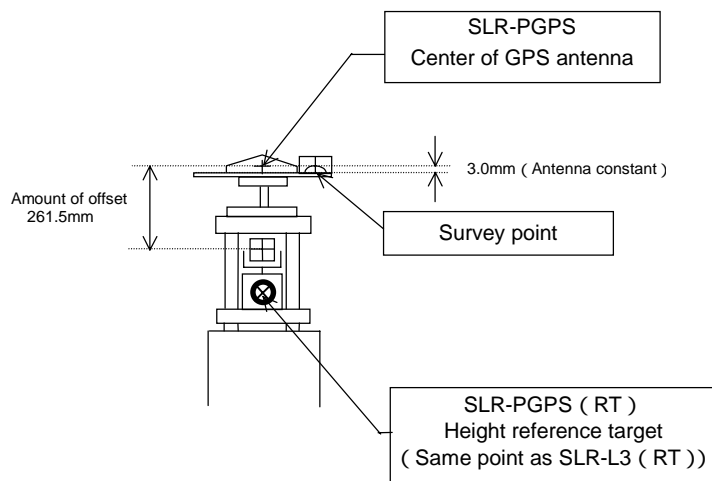

Figure 7. GPS antenna for SLR geodetic survey (1998 Tateyama)

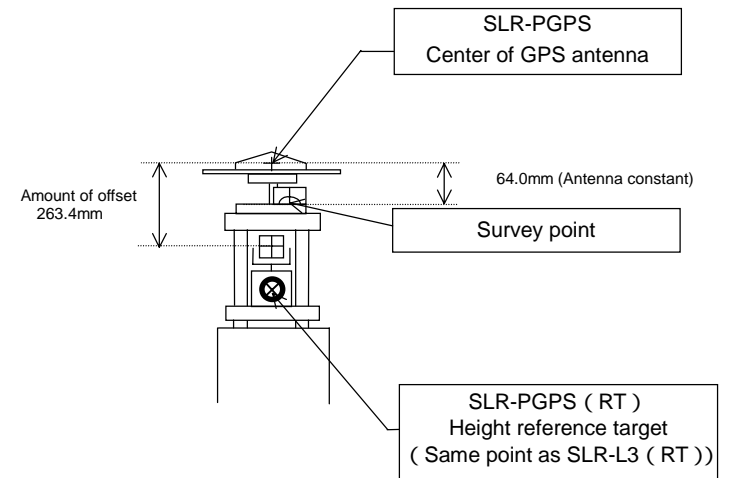

Figure 8. GPS antenna for SLR geodetic survey (1999 Tateyama)

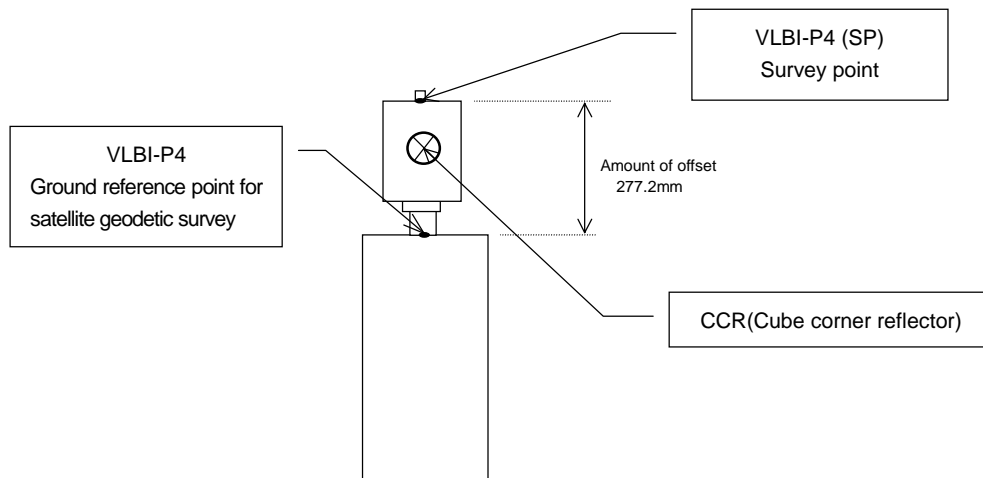

Figure 9. Ground reference point for satellite geodetic survey No.4 (Koganei station)

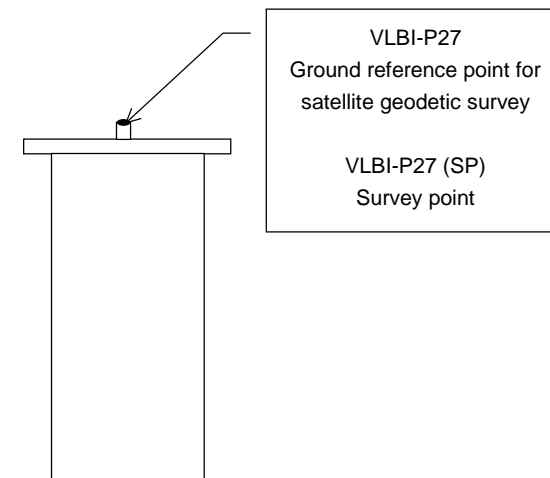

Figure 10. Ground reference point for satellite geodetic survey No.27 (Koganei station)

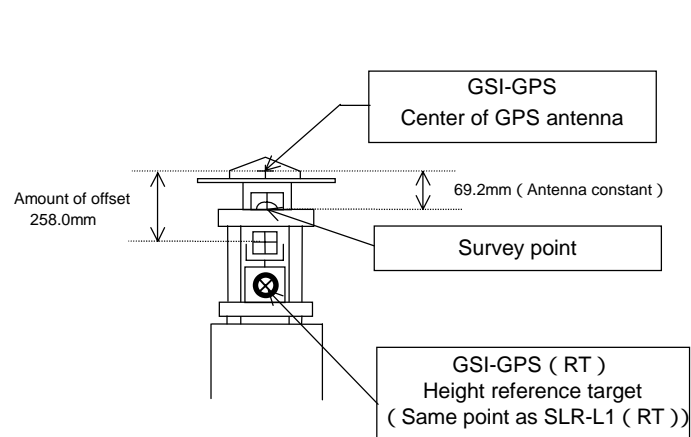

Figure 11. GSI-GPS electronic reference point (1998 Koganei)

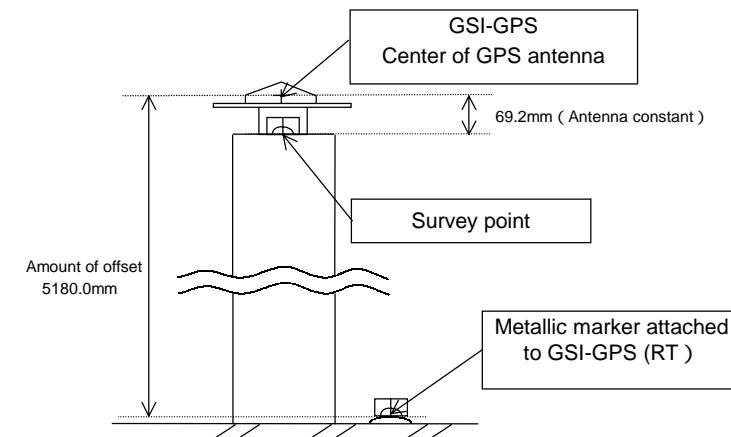

Figure 12. GSI-GPS electronic reference point (1998 Kashima)

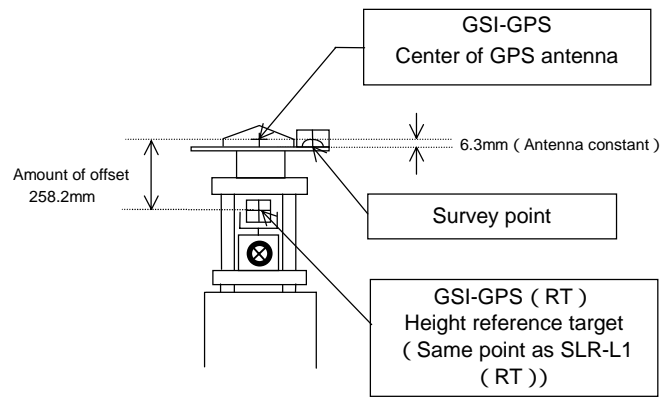

Figure 13. GSI-GPS electronic reference point (1999 Koganei)

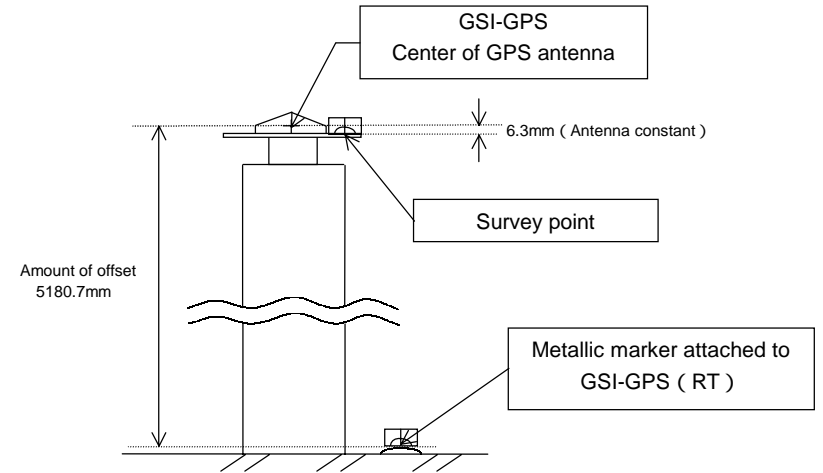

Figure 14. GSI-GPS electronic reference point (1999 Kashima)